

PRODUCT DATA SHEET

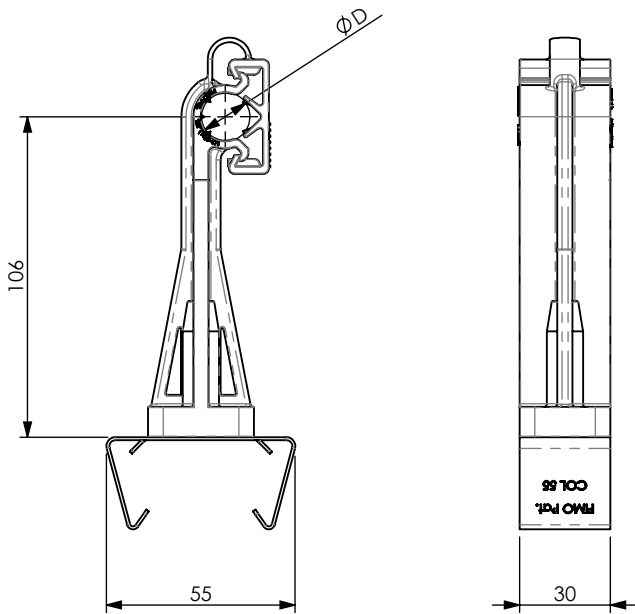

A) SPECIFICATIONS

- 1 Cable clamp. Material: PA6-VO, black colour, self extinguishing, halogen free (according UL94-VO).
- 2 Stainless Steel SNAP ON CLIP.
- 3 Stainless Steel 6x30 WOOD screws.

B) RESISTANCE TESTS

Working temperature : -40°C +125°C.
Installation temperature : -20°C +60°C.

C) DELIVERY MODALITIES

Packing in boxes. Label indicating: product code, article, quantity, production batch, FIMO logo and figure. (Customer code on request).

D) MOUNTING INSTRUCTIONS

On request

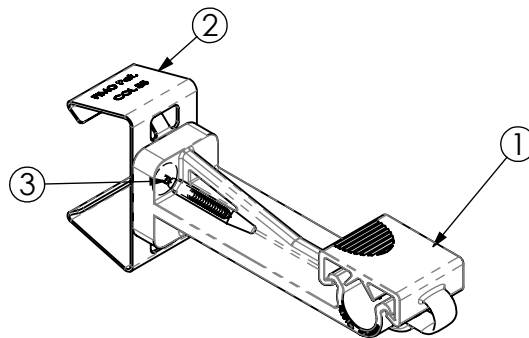

code	6150020012.55
article	KIT RAX 1/2" + COL 55

D		
15.5-17	50	0.0747kg

RI	DATE	DR	DATE	AP	Description:
02					KIT RAX 1/2" + COL 55 Radiating Cable Clamps
01					
00	17/12/2015	E.B.	17/12/2015	A.V.	
1 ST EMISSION					
					Use: Fixing of radiating cables on profiles/sections